

# 21" Installation Instructions



10821 North 23rd Avenue  
Phoenix, AZ 85029  
800-363-9865  
www.nltubular.com

**IMPORTANT:** Please take the time to read through the ENTIRE instructions prior to starting any work. Light Pipe material is very sharp when cut. Please use extreme caution when handling the light pipe. AVOID LEAVING THE PIPE EXPOSED TO THE SUN WITHOUT THE PROTECTIVE COATING OR DIFFUSERS IN PLACE PRIOR TO INSTALLATION.

## PARTS LIST

- A. Clear UV Protected, High Impact Acrylic Dome
- B. (4) Phillips Head Stainless Steel 1/4" Self-Tapping Screws
- C. Black Nylon Horse Hair Gasket (self-adhesive)
- D. Commercial Pure Grade, 1100 Series Aluminum Flashing
- E. (4) 1 1/2" Phillips Head Stainless Steel Screws
- F. (8) 1 1/2" Phillips Head Stainless Steel Screws
- G. Heavy Duty Foil Tape
- H. (2) 24" Light Pipe Sections
- I. (4) Phillips Head Stainless Steel 1/2" Sheet Metal Screws
- J. White Nylon Horse Hair Gasket (self-adhesive)
- K. (4) 1 1/2" Flathead Phillips Screws
- L. (3) Black Speed Nuts
- M. White Powder Coated Trim Ring
- N. (3) 1 1/2" Flathead Phillips Screws
- O. High Impact Acrylic Prismatic Diffuser

## TOOLS NEEDED

- Reciprocating Saw
- Measuring Tape
- Driver & Bits
- Phillips Screwdriver
- Clamp
- Caulking Gun
- Stud Finder
- Marking Pencil
- Tin Snips
- Flashlight
- Ladder
- Wire

## MATERIALS & TOOLS NEEDED TO BUILD CURB

- 2" x 10" Pressure Treated Lumber
- Hand or Circular Saw
- Wood Screws
- Galvanized Nails
- Roofing Material (to match existing roofing)

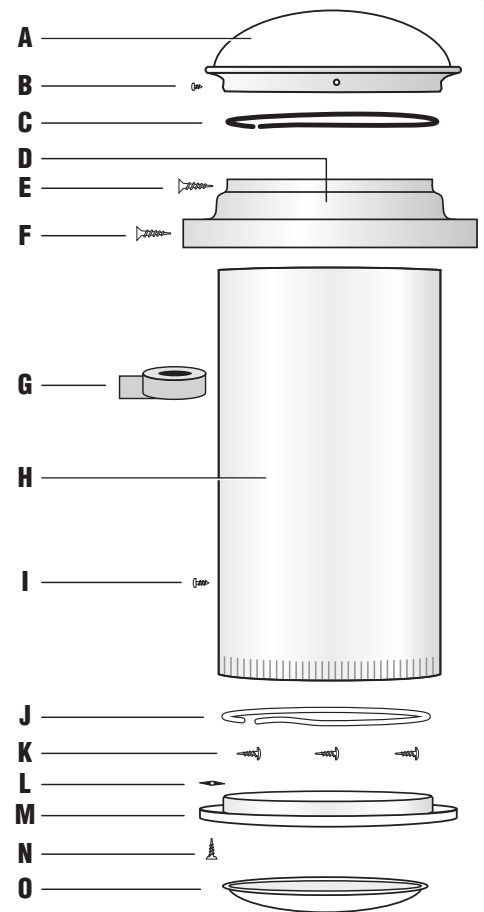

## Step 1

Find the desired location for the ceiling trim ring and ensure that there are no obstructions in the attic space between the roof and ceiling. With a stud finder locate the ceiling joists and center the ceiling ring between joists as close to the desired installation area as possible. Mark the center of the ceiling ring, drill a hole and insert piece of wire bent at a 90 degree angle. Rotate the wire around 360 degrees. While rotating, feel for resistance that could indicate wire runs or other obstructions.

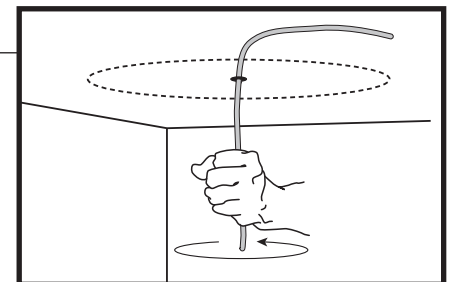

## Step 2

If there are no obstructions, scribe a mark around the ceiling trim ring (M), see diagram. Using a drywall saw, cut out the scribed mark in the ceiling.

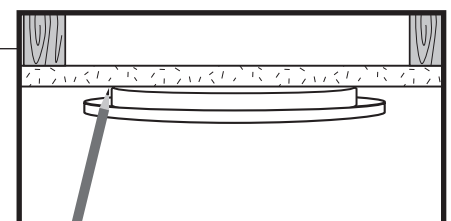

### Step 3

Peel the protective covering off the white horse hair gasket (**H**) and apply gasket to the INNER lip of the ceiling ring (**M**). This gasket ensures a dust free fit between the light pipe and the ceiling ring. Secure the ceiling ring to the ceiling by inserting a 1.5" flathead Phillips screw (**N**) into one of the three pre-drilled holes and screwing it up through the drywall into the speed nut (**L**) provided. Repeat this process for all three screws.

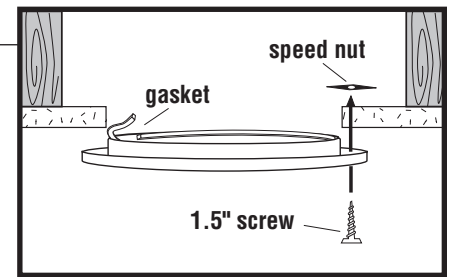

### Step 4

For the roof cutout, place a step ladder under the ceiling ring hole and place a flashlight on top of the ladder, the resulting flashlight beam will mark the location for the centering hole of the flashing unit on the roof. With a drill bit and appropriate extension rods, drill a pilot hole in the marked location on the bottom side of the roof. If there is access to the attic space, a plumb bob may also be used.

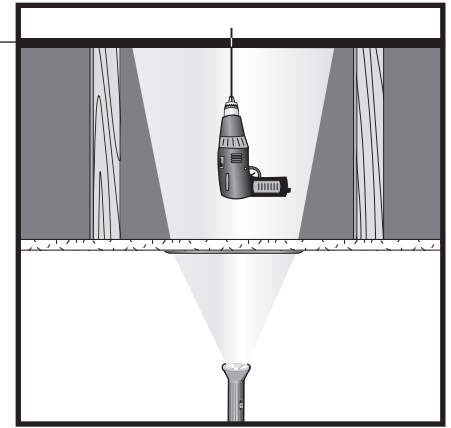

### Step 5

Assemble a curb with the **outside** dimensions slightly smaller than the width of flashing (approximately 27.5" x 27.5"). **The size of curb will vary depending on roofing material.** Use pressure-treated lumber secured at all four corners with wood screws or galvanized nails (use 2" x 10" lumber - adhere to local building codes).

**NOTE:** Do not build curb prior to being on job site.

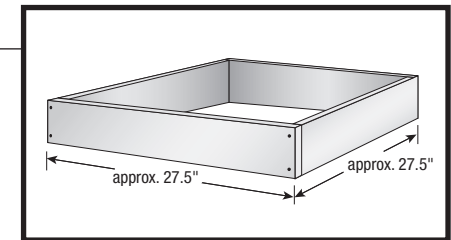

### Step 6

On the roof, find the desired location to install the unit. Ensure that there are no obstructions (wiring, framing, etc.) to hinder the installation. Outline the diameter of the hole that the pipe will pass through by turning the flashing upside down and marking the inside of the flashing unit. With a reciprocating saw, cut the diameter of the hole **1" larger than the area marked.**

**IMPORTANT:** The light pipe must pass between the roof rafters. **DO NOT CUT THROUGH ANY FRAMING MEMBER.**

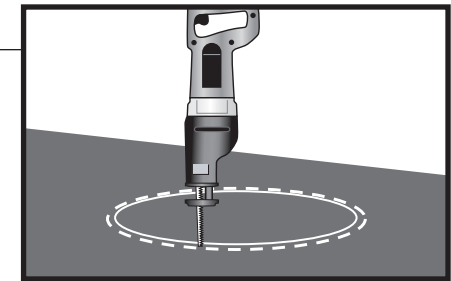

### Step 7

Place curb over opening and toe-nail into existing roofing using galvanized nails. If necessary, build blocking to ensure the curb is secure. Wrap curb with roofing material to prevent leaking.

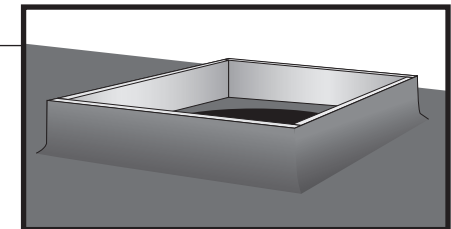

### Step 8

Attach the skylight flashing (**D**) to the curb using the (8) 1 1/2" Phillips head stainless steel screws (**F**) provided through the pre-drilled holes on the skylight flashing lip. Peel the protective backing off the black nylon horse hair gasket (**C**) and apply gasket to the INNER lip the flashing collar.

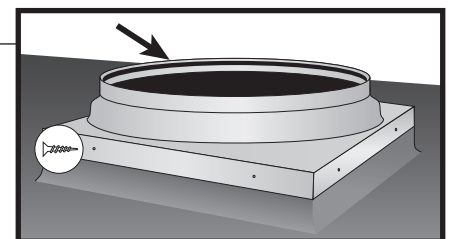

### Step 9

To assemble light pipe, peel back the protective coating that covers the mirror coating on the opposite edge of the double sided tape, remove paper cover over double sided tape and overlap and seal edges. Put pressure on both sides of seal to ensure a good bond. Secure tube using the (2) 1/2" sheet metal screws (I) provided. Then place foil tape (G) over the entire seam to strengthen seal. When joining two pipe sections together, place crimped end into the next section of pipe. Secure with a 1/2" sheet metal screws (I) provided and seal joints with foil tape.

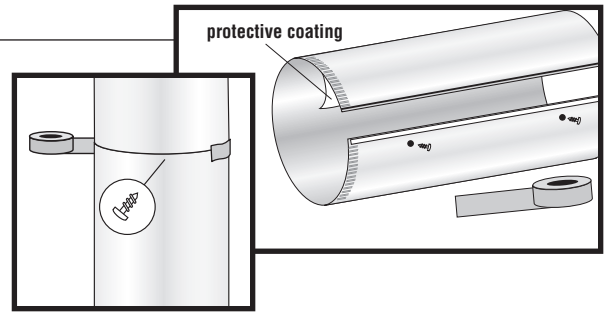

### Step 10

Insert the pipe, crimped end down, through the flashing unit and gently rock pipe back and forth with slight downward pressure until pipe terminates evenly with the inner collar of the ceiling ring. Secure bottom of light pipe to ceiling ring with the tek screws (K). Trim any excess light pipe with tin snips.

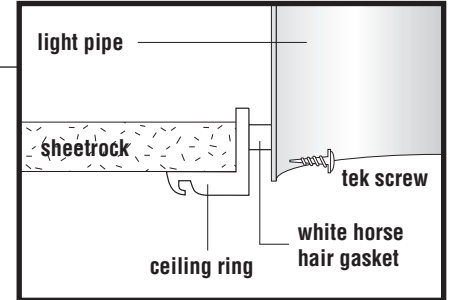

### Step 11

If there is excess pipe sticking out of the flashing, using tin snips, cut from the top down to the lip of the flashing and trim off the excess pipe. (Use caution when handling the light pipe - edges of the light pipe are extremely sharp when cut).

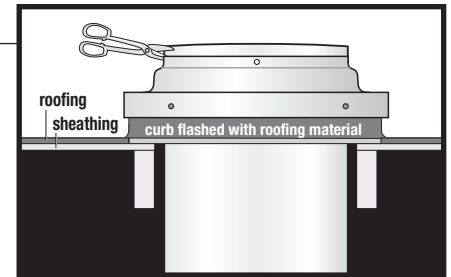

### Step 12

Place the dome (A) on top of the flashing unit. Secure the dome to flashing by screwing in the (4) self-tapping Phillips head 1/4" screws (B) provided into the pre-drilled holes in the dome collar.

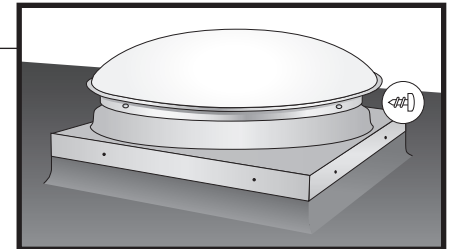

### Step 13

Place the diffuser (O) into the trim ring (M). Start with inserting one end of the diffuser lip into the channel on the inside of the trim ring. Slightly bend the diffuser and work the rest of the diffuser lip into the trim ring channel until the diffuser sits completely inside the trim ring.

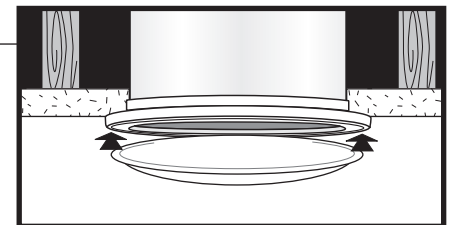

Please fill out the form and mail it to: Natural Light Energy Systems • 10821 North 23rd Avenue • Phoenix, AZ 85029

## REGISTRATION

Installer Name: \_\_\_\_\_ Date of Purchase: \_\_\_\_\_

Customer Name: \_\_\_\_\_ Phone: \_\_\_\_\_

Address: \_\_\_\_\_ Email: \_\_\_\_\_

### Customer Survey

Are you satisfied with the performance? Y N      Were you satisfied with the installation job? Y N

What made you choose our product? \_\_\_\_\_