



IMPORTANT: Please take the time to read through the ENTIRE instructions prior to starting any work. Light Pipe material is very sharp when cut. Please use extreme caution when handling. **AVOID LEAVING THE PIPE EXPOSED TO THE SUN WITHOUT THE PROTECTIVE COATING OR DIFFUSERS IN PLACE PRIOR TO INSTALLATION.**

TOOLS/MATERIALS NEEDED

- Caulk
- Caulking Gun
- Driver & Bits
- Drywall Saw
- Flashlight
- Gloves
- Hammer
- Marking Pencil
- Measuring Tape
- Phillips Screwdriver
- Reciprocating Saw
- Safety Goggles
- Stud Finder
- Tin Snips
- Utility Knife
- Wire

TUBULAR SKYLIGHT KIT PARTS

- A.** Clear UV Protected, High Impact Acrylic Dome
- B.** (4) Phillips Head Stainless Steel ¼" Self-Tapping Screws
- C.** Black Nylon Horse Hair Gasket (self-adhesive)
- D.** Aluminum Flashing - Pitched or Flat
- E.** (6) 1 ½" Phillips Head Stainless Steel Screws
- F.** Heavy Duty Foil Tape
- G.** (2) 24" Light Pipe Sections
- H.** White Nylon Horse Hair Gasket (self-adhesive)
- I.** (8) Phillips Head Stainless Steel ½" Self-Tapping Screws
- J.** (3) Black Speed Nuts
- K.** Ceiling Ring
- L.** (3) 1 ½" Flat Head Phillips Screws
- M.** High Impact Acrylic Diffuser
- N.** White Powder Coated Aluminum Trim Ring

ADDITIONAL PARTS (sold separately)

- a.** Tile Flashing Skirt
- b.** Turret Extension (Optional)

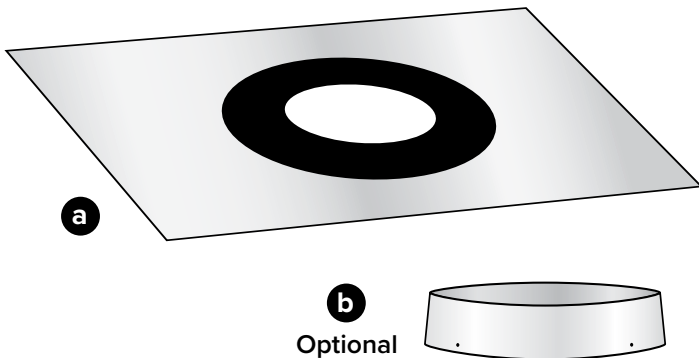

PRECAUTIONS:

1. Ensure normal safety precautions are taken when using tools, ladder and walking on roofs.
2. Do not cut any structural members in the house.
3. Install only in dry weather.

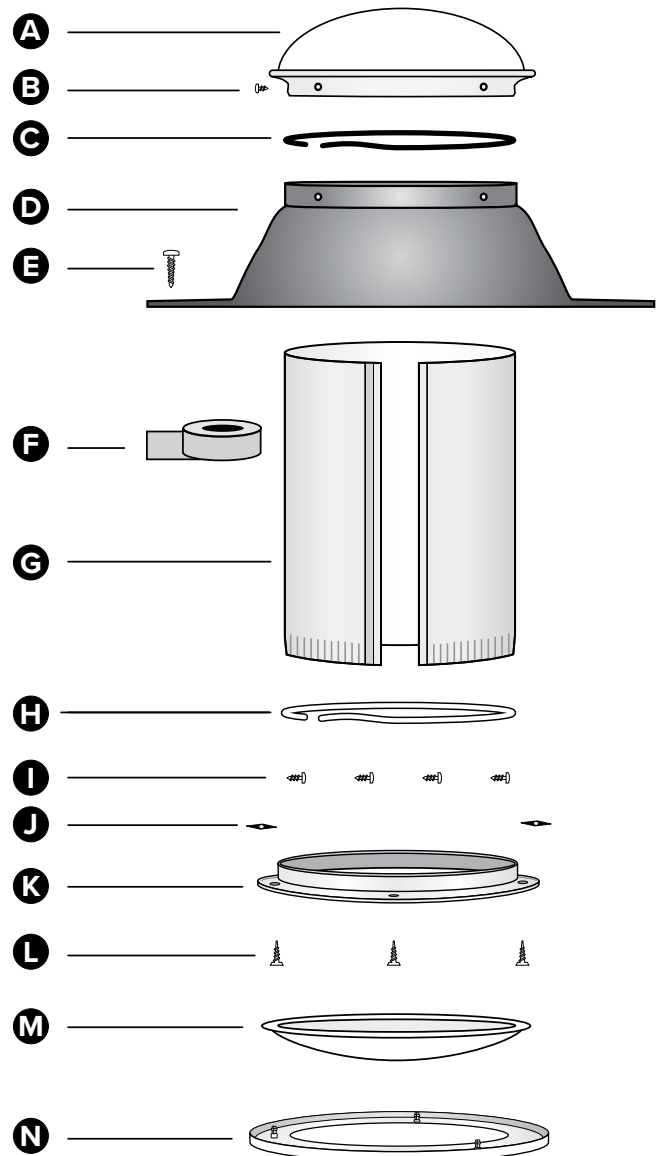

IMPORTANT INSTALLATION POINTERS – PLEASE READ BEFORE BEGINNING:

1. It is critical to plan the placement of the tubular skylight so that hole cut on roof and ceiling trim ring are aligned. Ensure that hole on roof is between framing trusses. **DO NOT CUT ANY STRUCTURAL FRAMING.**
2. When determining the location of the unit, southern exposure is recommended. Also consider potential problems such as objects shading the unit during certain times of the day.
3. Although adjustable elbows are available, straight light pipe runs result in higher light output and easier installation.
4. Prior to starting the job, **CUT PACKING STRAPS ON THE LIGHT PIPE AND UNCOIL THE TUBES.**
5. It's highly critical to check for obstructions above the ceiling which may hinder installation. If possible, visually check to ensure that there are no electrical wires or other obstructions where you plan to install the skylight. If you cannot check visually, use a piece of wire as outlined in Step 1.

STEP 1

Find the desired location for the ceiling trim ring and ensure that there are no obstructions in the attic space between the roof and ceiling. With a stud finder locate the ceiling joists and center the ceiling ring between joists as close to the desired installation area as possible. If you cannot check visually for obstructions, mark the center of the ceiling ring, drill a hole and insert piece of wire bent at a 90 degree angle. Rotate the wire around 360 degrees. While rotating, feel for resistance that could indicate wire runs or other obstructions.

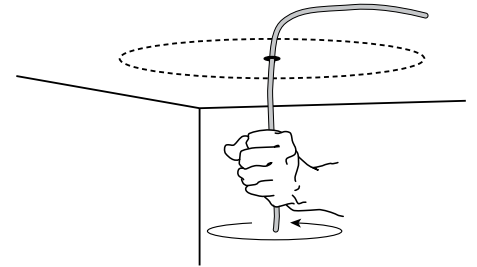

STEP 2

If there are no obstructions, scribe a mark around the ceiling ring (K), see diagram. Using a drywall saw, cut out the scribed mark in the ceiling.

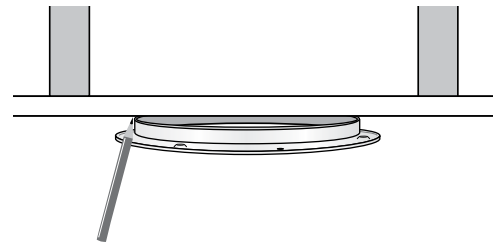

STEP 3

Peel the protective covering off the white horse hair gasket (H) and apply the gasket to the INNER lip of the ceiling ring (K). This gasket ensures a dust free fit between the light pipe and the ceiling ring. Secure the ceiling ring to the ceiling by inserting a 1 1/2" flathead Philips screw (L) into one of the three pre-drilled holes and screwing it up through the drywall into the speed nut (J) provided. Repeat this process for all three screws.

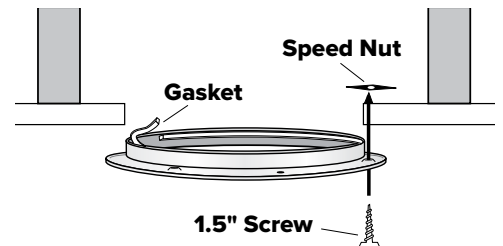

STEP 4

For the roof cutout, place a step ladder under the ceiling ring hole and place a flashlight on top of the ladder. The resulting flashlight beam will mark the location for the centering hole of the flashing unit on the roof. With a drill bit and appropriate extension rods, drill a pilot hole in the marked location on the bottom side of the roof. If there is access to the attic space, a plumb bob may also be used.

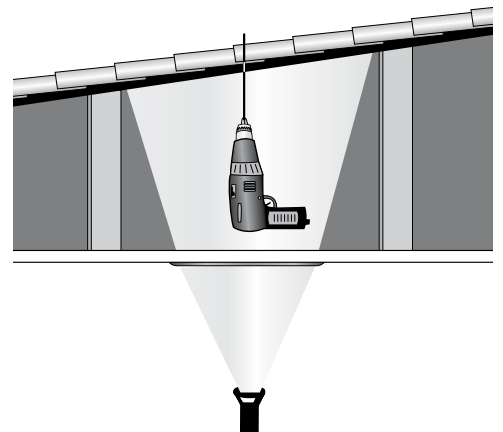

STEP 5

On the roof, locate the centering hole drilled in Step 4 and carefully remove surrounding tiles. Remove enough tiles to accommodate the flashing skirt. Place flashing over the location where the unit will be installed and mark around the flashing footprint onto the furring strips. Remove the portion of the furring strips where the flashing will be installed (allowing the flashing to sit directly on roof sheathing).

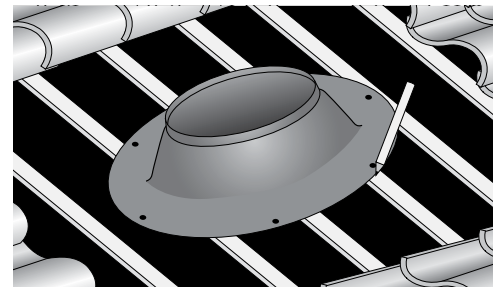

STEP 6

Outline the diameter of the hole that the pipe will pass through by turning the flashing (D) upside down and center it over the hole drilled in Step 4. Mark the **INSIDE** lip of the flashing as shown.

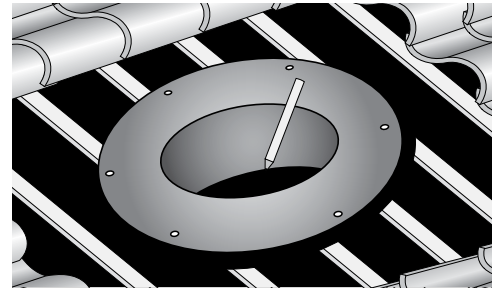

STEP 7

With a reciprocating saw, cut the diameter of the hole a **MINIMUM OF 1" LARGER** than the area marked in previous step.

NOTE: A larger hole can be cut to accommodate angled pipe installations.

IMPORTANT: The light pipe must pass between the roof rafters. **DO NOT CUT THROUGH ANY FRAMING MEMBER.**

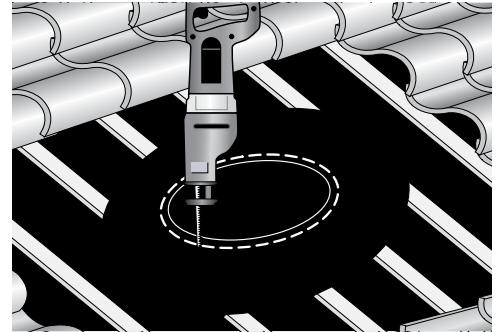

STEP 8

Caulk the underside of the flashing (D) with caulk. Two concentric rings of caulking material is sufficient. Turn the flashing right-side-up and center over hole cut in the previous step. Press firmly down on the flashing until caulk slightly squeezes out at the edges of the flashing.

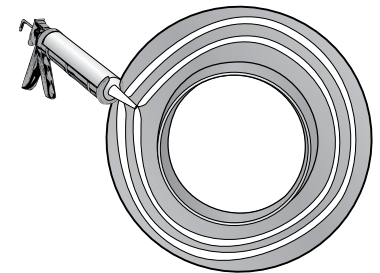

STEP 9

Secure flashing to the roof with the Phillips head 1 1/2" screws (E) provided. Evenly space the screws around the lip of the flashing. Place first screw at the 12:00 o'clock position, then next diagonally over from it at 6:00. The third screw should go at 9:00 and the next screw diagonally across at 3:00, etc. Caulk over the screw heads.

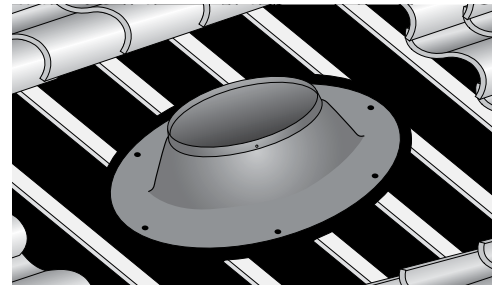

STEP 10

Place the flashing skirt (a) over the flashing. Press down the rubber ring all around the flashing.

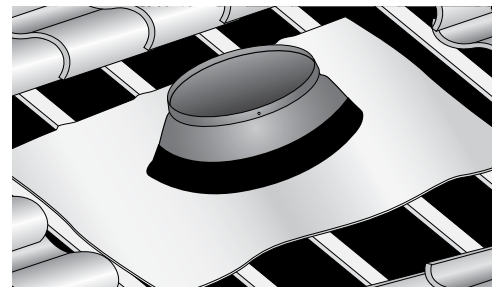

STEP 10A - OPTIONAL TURRET EXTENSION STEP

For S-tile installations, an optional 3" turret extension can be used. Slip the turret extension (b) over the flashing lip and secure with the (4) provided screws.

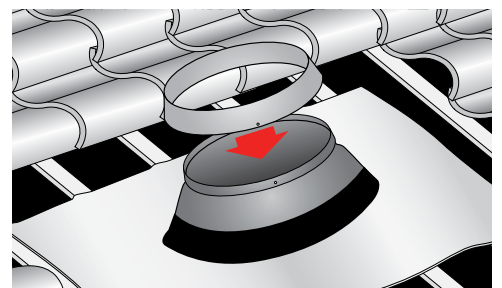

STEP 11

Peel the protective backing off the black horse hair gasket (C) and apply the gasket on the INNER lip of the flashing collar or the turret extension.

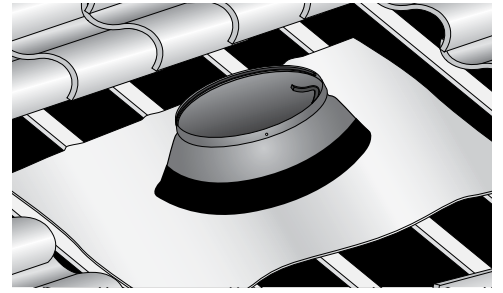

STEP 12

Using a utility knife, score the protective film by cutting along the outside of the channel of the light pipe. Then peel off all of the protective plastic film from all areas of the light pipe (G). To assemble the light tube, insert the light pipe into the channel so that it forms a round tube. After insertion, pull both sides back to ensure the pipe is locked into place.

IMPORTANT: All of the plastic must be removed to avoid having the color of the plastic reflecting through the diffuser.

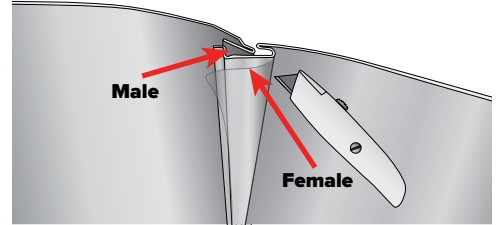

STEP 13

Join the two light pipe sections (G) together by placing the crimped end of one of the sections into the non-crimped end on the other section. Secure with (2) 1/2" sheet metal screws (I) and seal joints with the heavy-duty foil tape (F).

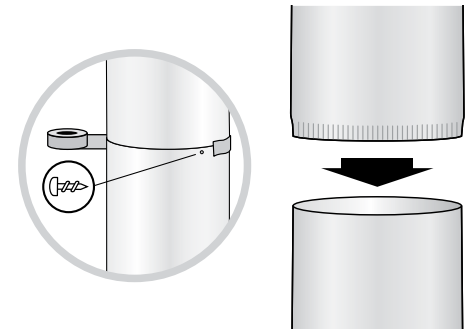

STEP 14

Insert light pipe (G) through the flashing (D) with **CRIMPED END DOWN** and gently rock pipe back and forth with slight downward pressure. Slide the pipe down until it terminates evenly with the inner collar of the ceiling ring (K).

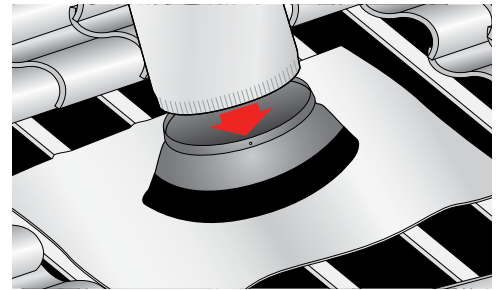

STEP 15

Back inside, secure bottom of light pipe to ceiling ring with (4) self-tapping screws (I). If there's any excess light pipe, trim with tin snips.

CAUTION: The light pipe is extremely sharp, handle with care and wear gloves.

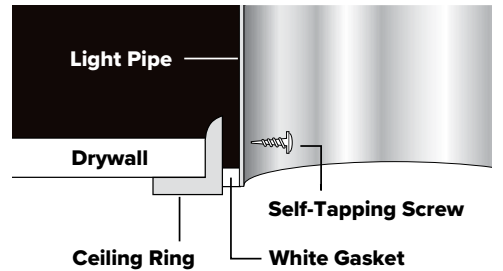

STEP 16

Back on the roof, if there is excess pipe sticking out of the flashing, using tin snips, cut from the top down to the lip of the flashing and trim off the excess pipe.

CAUTION: The light pipe is extremely sharp, handle with care and wear gloves.

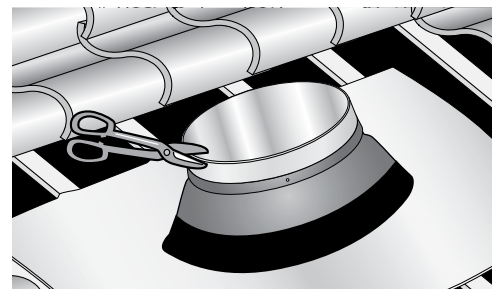

STEP 17

Place dome (A) on top of the flashing. Secure the dome to flashing by screwing in the (4) self-tapping Phillips head 1/4" (B) screws provided into the pre-drilled holes in the dome collar.

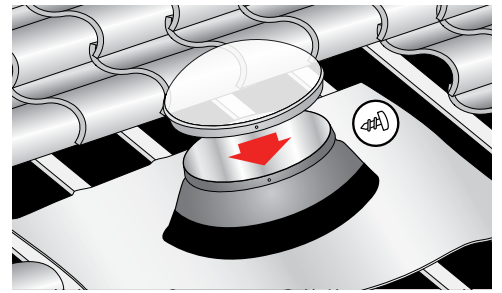

STEP 18

At the HIGH side of the roof towards the ridge, replace the tiles over the flashing skirt. Cut tiles to fit around flashing. Some furring strips may need to be replaced on top of flashing footprint to support tiles.

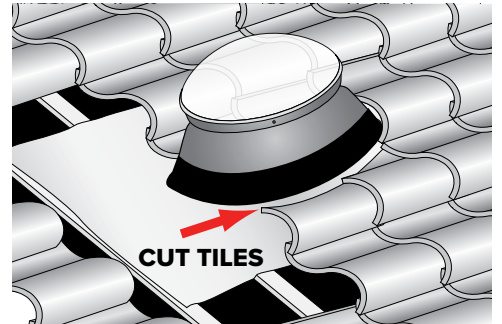

STEP 19

Replace the tiles on the LOW side of the roof, but keep skirt above the tiles and reshape the skirt aluminum to form around the tiles. Apply sealant on the underside of the tile skirt to secure the skirt to the tiles.

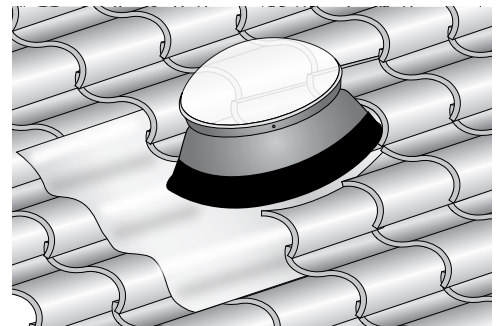

STEP 20

Place the diffuser (M) into the white powder coated trim ring (N).

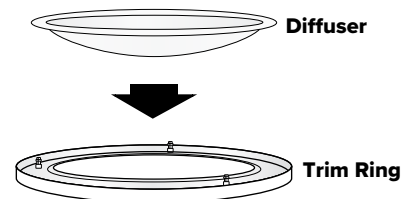

STEP 21

Line up the three steel pins of the white ceiling trim ring (N) (four pins on the 18" model) with the holes on the ceiling ring (K). Push up to snap in place.

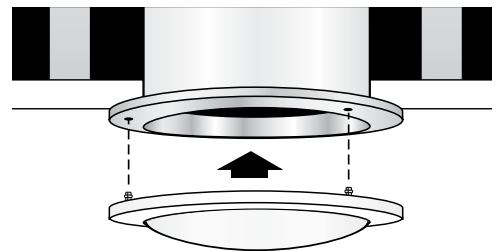



Tubular Skylight Lifetime Limited Warranty

Natural Light Energy Systems (hereinafter NLES) warrants any tubular skylight manufactured by NLES to be free from defects in materials and workmanship to the original residential purchaser (hereinafter CONSUMER) from the date of purchase. All aspects of the Warranty are subject to the following limitations, terms and conditions.

1. DURATION OF WARRANTY

If a NLES tubular skylight (hereinafter "Equipment") is determined to have a defect in material or workmanship, NLES will, at its sole discretion, repair or replace the defective part at NO CHARGE to the CONSUMER, (excluding labor, and applicable shipping and handling costs) for the duration of the CONSUMER'S ownership of the original equipment (hereinafter "LIFETIME").

2. LIMITATIONS OF COVERAGE

This Warranty extends only to the CONSUMER for damage resulting from defects in materials and workmanship, it does not extend to damage caused by the CONSUMER'S neglect or abuse, or by accident, to damage caused by wind, hail or abnormal weather conditions, or to damage caused by acts of God, civil insurrection or extraordinary circumstances which are beyond the control of NLES.

NLES shall not be liable for any direct or indirect damage resulting from the use of the Equipment, and in no event shall the extent of the Warranty coverage exceed the purchase price of the Equipment.

NLES assumes no liability for the determination of the proper equipment necessary to meet a CONSUMER'S requirements, nor does it authorize others to assume such obligations on its behalf.

3. MISCELLANEOUS

In order to be considered for validation, all claims for Warranty coverage must be accompanied by a copy of the purchase agreement indicating the date of initial installation, NLES reserves the right to inspect the tubular skylight prior to honoring any Warranty claim.

This Warranty gives you specific legal rights, and you may have other rights which may vary from state to state. Any and all inquiries or claims under this Warranty must be submitted in writing to **Natural Light Energy Systems, Attn: Warranty Department, 10821 N. 23rd Avenue, Phoenix, AZ 85029** or by e-mail to info@nltubular.com.



To register your Tubular Skylight, please visit
www.nltubular.com/customer-service/warranty-registration/



REGISTER NOW